

Features

- Very Low Forward Voltage Drop
- Guard Ring Construction for Transient Protection
- High Conductance
- **Lead, Halogen and Antimony Free, RoHS Compliant "Green" Device (Notes 4, 5 and 6)**

Mechanical Data

- Case: SOT-23
- Case Material: Molded Plastic. UL Flammability Classification Rating 94V-0
- Moisture Sensitivity: Level 1 per J-STD-020D
- Polarity: See Diagram
- Leads: Solderable per MIL-STD-202, Method 208
- Terminals: SDM40E20L/S/A Finish — Matte Tin Finish annealed over Alloy 42 leadframe.
SDM40E20LC Finish — Matte Tin Finish annealed over CDA194 leadframe.
- Marking Information: See Page 2
- Ordering Information: See Page 2
- Weight: 0.008 grams (approximate)

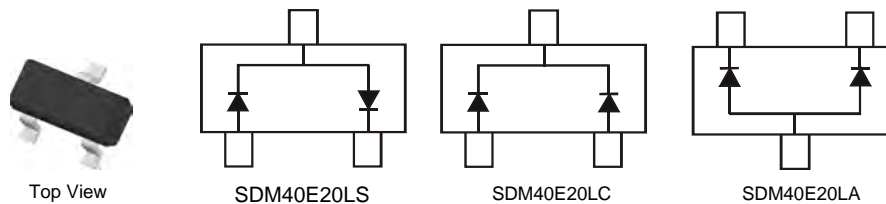

Maximum Ratings @ $T_A = 25^\circ\text{C}$ unless otherwise specified

Single phase, half wave, 60Hz, resistive or inductive load.
For capacitance load, derate current by 20%.

Characteristic	Symbol	Value	Unit
Peak Repetitive Reverse Voltage	V_{RRM}	20	V
Working Peak Reverse Voltage	V_{RWM}		
DC Blocking Voltage	V_R		
RMS Reverse Voltage	$V_{R(RMS)}$	14	V
Forward Continuous Current (Note 1)	I_{FM}	0.4	A
Non-Repetitive Peak Forward Surge Current 8.3ms single half sine-wave superimposed on rated load	I_{FSM}	2	A

Thermal Characteristics

Characteristic	Symbol	Value	Unit
Power Dissipation (Note 1) (Note 2)	P_D	225	mW
		300	
Typical Thermal Resistance Junction to Ambient (Note 1) (Note 2)	$R_{\theta JA}$	444	$^\circ\text{C}/\text{W}$
		333	
Operating and Storage Temperature Range	T_J, T_{STG}	-65 to +125	$^\circ\text{C}$

Electrical Characteristics @ $T_A = 25^\circ\text{C}$ unless otherwise specified

Characteristic	Symbol	Min	Typ	Max	Unit	Test Conditions
Reverse Breakdown Voltage (Note 3)	$V_{(BR)R}$	20	—	—	V	$I_R = 0.5\text{mA}$
Forward Voltage Drop	V_F	—	—	0.310	V	$I_F = 0.1\text{A}$
		—	—	0.430		$I_F = 0.5\text{A}$
Leakage Current (Note 3)	I_R	—	—	100	μA	$V_R = 10\text{V}$
		—	—	250		$V_R = 20\text{V}$
Total Capacitance	C_T	—	120	—	pF	$f = 1\text{MHz}, V_R = 0\text{VDC}$

- Notes:
1. Device mounted on FR-5 1.0 x 0.75 x 0.062 inch PCB pad layout.
 2. Device mounted on Alumina PCB, 0.4 inch x 0.3 inch x 0.024 inch pad layout.
 3. Short duration pulse test used to minimize self-heating effect.
 4. No purposefully added lead. Halogen and Antimony Free.
 5. Diodes Inc.'s "Green" policy can be found on our website at http://www.diodes.com/products/lead_free/index.php.
 6. Product manufactured with Green Molding Compound and does not contain Halogens or Sb_2O_3 Fire Retardants.

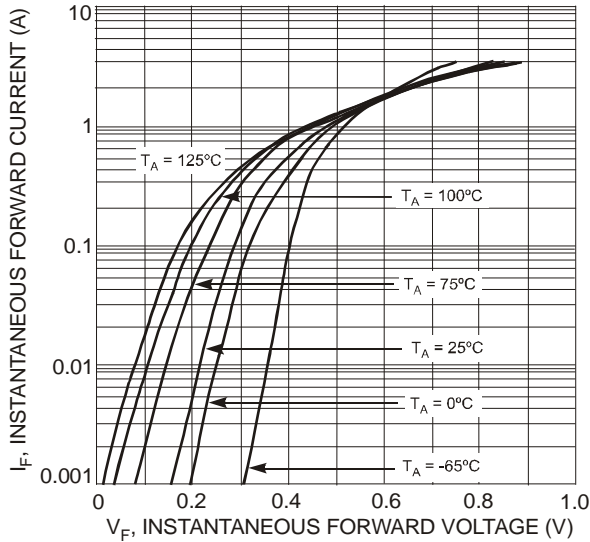

Fig. 1 Typical Forward Characteristics, Per Element

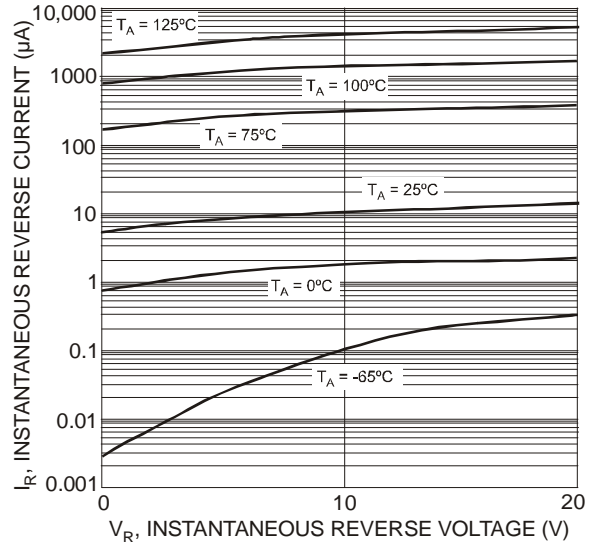

Fig. 2 Typical Reverse Characteristics, Per Element

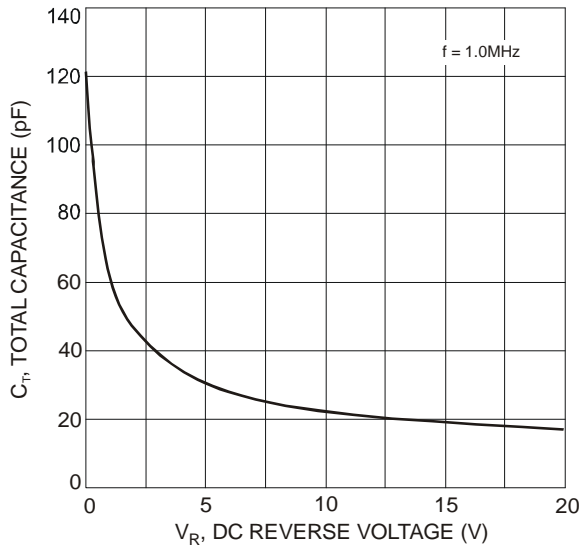

Fig. 3 Total Capacitance vs. Reverse Voltage, Per Element

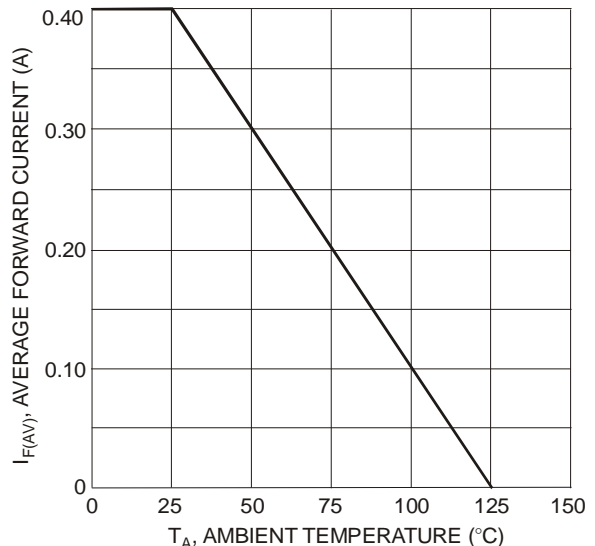

Fig. 4 Forward Current Derating Curve, Per Element

Ordering Information (Note 7)

Part Number	Case	Packaging
SDM40E20LS-7-F	SOT-23	3000/Tape & Reel
SDM40E20LC-7	SOT-23	3000/Tape & Reel
SDM40E20LA-7	SOT-23	3000/Tape & Reel

Notes: 7. For packaging details, go to our website at <http://www.diodes.com/datasheets/ap02007.pdf>.

Marking Information

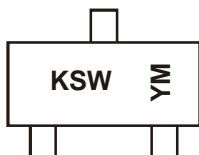

KSW = SDM40E20LS Product
Type Marking Code
YM = Date Code Marking
Y = Year ex: T = 2006
M = Month ex: 9 = September

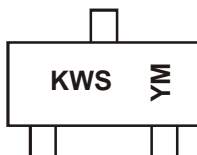

KWS = SDM40E20LC Product
Type Marking Code
YM = Date Code Marking
Y = Year ex: T = 2006
M = Month ex: 9 = September

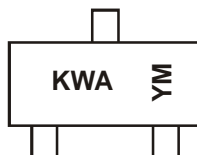

KWA = SDM40E20LA Product
Type Marking Code
YM = Date Code Marking
Y = Year ex: T = 2006
M = Month ex: 9 = September

Date Code Key

Year	2005	2006	2007	2008	2009	2010	2011	2012	2013	2014	2015
Code	S	T	U	V	W	X	Y	Z	A	B	C

Month	Jan	Feb	Mar	Apr	May	Jun	Jul	Aug	Sep	Oct	Nov	Dec
Code	1	2	3	4	5	6	7	8	9	O	N	D

Package Outline Dimensions

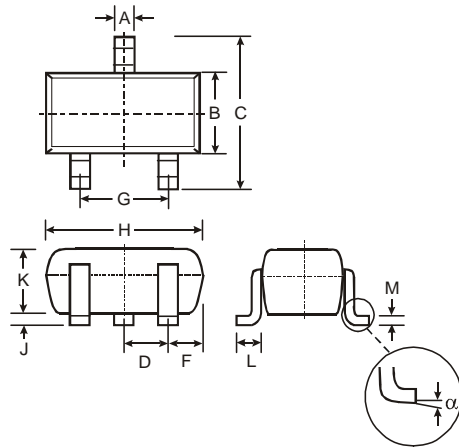

SOT-23		
Dim	Min	Max
A	0.37	0.51
B	1.20	1.40
C	2.30	2.50
D	0.89	1.03
F	0.45	0.60
G	1.78	2.05
H	2.80	3.00
J	0.013	0.10
K	0.903	1.10
L	0.45	0.61
M	0.085	0.180
α	0°	8°
All Dimensions in mm		

Suggested Pad Layout

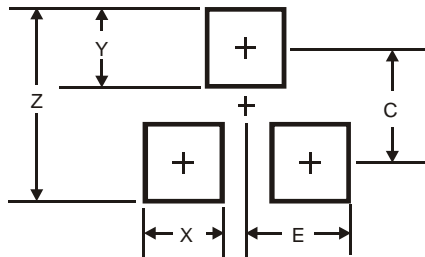

Dimensions	Value (in mm)
Z	2.9
X	0.8
Y	0.9
C	2.0
E	1.35

IMPORTANT NOTICE

Diodes Incorporated and its subsidiaries reserve the right to make modifications, enhancements, improvements, corrections or other changes without further notice to any product herein. Diodes Incorporated does not assume any liability arising out of the application or use of any product described herein; neither does it convey any license under its patent rights, nor the rights of others. The user of products in such applications shall assume all risks of such use and will agree to hold Diodes Incorporated and all the companies whose products are represented on our website, harmless against all damages.

LIFE SUPPORT

Diodes Incorporated products are not authorized for use as critical components in life support devices or systems without the expressed written approval of the President of Diodes Incorporated.